

Robot, Feed Thyself: Plugging In to Unmodified Electrical Outlets by Sensing Emitted AC Electric Fields

Brian Mayton, Louis LeGrand, and Joshua R. Smith

Go slow, my soul, to feed thyself
Upon his rare approach —
Go rapid, lest Competing Death
Prevail upon the Coach —
—Emily Dickinson

Abstract—We describe a robot that is able to autonomously plug itself in to standard, unmodified electrical outlets by sensing the 60Hz electric fields emitted from the outlet. The building electrical infrastructure is not modified in any way. Unlike previous powerline localization work, no additional signal is injected in the powerlines—the already present AC power carrier signal in the outlet is used as the localization beacon. This technique is faster, more accurate, and potentially less expensive than previously reported vision-based systems for autonomous plugging in.

I. INTRODUCTION

The ability for robots to plug themselves in to standard electrical outlets is a practically important and challenging mobile manipulation problem. Autonomous plugging in is practically important because in principle it allows robots to operate for long periods of time without human assistance and without a “home base” for battery recharging. A robot with this capability could potentially migrate long distances, by moving from one environment to another as long as the destination has a standard electrical outlet it can use to “feed” itself. By contrast, using a robot-specific power base confines the robot to sites where such special-purpose recharging infrastructure (currently extremely rare or nonexistent in environments not specifically designed for robotic operation) exists. In addition to being rare, existing charging base stations for today’s inexpensive personal robots (such as Roomba or Rovio) use unreliable mechanisms that sometimes fail to provide electrical connections, even when the robots appear to be positioned properly. A standard electrical outlet, on the other hand, rarely fails to provide power after a plug is inserted: it is a mature technology that is robust, reliable, and safe, due to decades of refinement and use by humans.

Autonomous plugging in is challenging because it requires both mobility and manipulation, and in particular requires accurate positioning of the plug with respect to the outlet, with millimeter-scale precision. At the location where the



Fig. 1. The MARVIN Mobile Manipulation Platform is able to plug itself in to a standard U.S. electrical outlet. The outlet and building wiring are completely standard and unmodified; the robot’s plug has been instrumented to sense the 60Hz AC electrical emissions from the outlet. After the robot has navigated to the vicinity of the outlet, the plugging in process is guided entirely by measurements of these electrical emissions; the outlet is not sensed visually at all.

most precision is needed—the last millimeter—the plug typically occludes the robot’s view of the socket, making it difficult to implement closed loop control with vision. Another difficulty with vision is the requirement to calibrate the camera to the arm. Our approach avoids both of these difficulties by instrumenting one of the items that must be aligned—the plug—to sense the signal naturally generated by the other item—the socket. A further advantage of our approach is that it provides information about the properties of the resource being sought, in this case electricity, rather than just the position of the socket. For example, the robot could determine, before attempting to plug in, whether the outlet is powered.

II. PROBLEM DEFINITION (THE RULES)

Since we desire the robot to be able to plug itself in to any outlet, we are not allowed to modify the outlet at all.

This work was supported by Intel Labs Seattle
Brian Mayton is with Intel Labs Seattle and University of Washington
bmayton@cs.washington.edu
L. LeGrand and J.R. Smith are with Intel Labs Seattle, 1100
NE 45th Street, Seattle, WA 98105 louis.l.legrand,
joshua.r.smith@intel.com

But since the plug is part of the robot and travels everywhere with the robot, we are allowed to modify the plug in any way we want, as long as it still can perform its intended power delivery purpose, including being plugged in by humans if desired.

We would like the technique to be as fast and as robust as possible. The solution should be potentially applicable to lower cost robotics hardware. The use of closed loop control based on an error signal between the two elements being aligned (plug and socket) means that in principle, less precise actuation could be used, at the cost of speed.

III. RELATED WORK

A. *Self-feeding robots*

The concept of self-feeding robots was demonstrated in 1950 by G. Walter with his autonomous robotic “tortoise” named Elsie. It used a pair of simple vacuum tube amplifiers, rather than digital computation, to avoid obstacles and seek light sources. When the robot’s battery voltage ran low, it would increase the gain of its photodetector, causing it to move toward a lamp placed inside a “hutch” where the robot could theoretically recharge. [1]

B. *Plugging in*

Another early analog robot known as the Beast is reported to have patrolled the halls of Johns Hopkins University’s Applied Physics Laboratory plugging itself in as early as 1965. [2], [3] Like Elsie, this device did not use digital computation, but rather was based on discrete analog components. Two versions of the system appear to have existed. One found the outlets by feel, and the other used optical sensing, requiring high visual contrast between the outlets and the wall. Thus, this early example did not entirely meet the “no infrastructure modification” property that is so compelling for electrical foraging, as it required dark-colored outlets on light-colored walls. Another difference is that the Beast did not use a general purpose manipulator; the manipulator could only be used for the special purpose of plugging in.

More recently, E. Torres-Jara’s 2002 Masters thesis [3] describes a digital robot that plugs itself into outlets to recharge. It used a pair of cameras, one to avoid obstacles and another to locate outlets and align the plug. Like the Beast, it had a special purpose manipulator for plugging in.

Bagepalli, Zamora, and Sanchez at UTPA built a robot named “Charger” as an undergraduate senior design project in 2005 that locates outlets and plugs itself in. [4] It used electric field sensing and a large antenna for locating outlets on the wall. The antenna was wired to a high-gain amplifier, the output of which was rectified and measured by an A/D converter. No analog or digital filtering was done to make the E-field sensing specific to powerline frequencies. After roughly finding the outlet by its electric field, the system switched to a vision-based system for the final alignment. Like the previously mentioned robots, it also used a special-purpose manipulator for plugging in.

Most recently, Willow Garage has demonstrated plugging in using the PR2, their versatile mobile manipulation platform. [5] They are operating under the “rules” presented in the previous section. Their approach relies on vision for long and medium range sensing, and touch for close range sensing. Their work is also the first we are aware of where a general-purpose manipulator is used to grasp the plug and guide it into the outlet, rather than a dedicated special-purpose manipulator.

The PR2 first estimates the outlet pose relative to the robot using vision. Next, it picks up the electrical plug. The PR2’s plug is square, so its parallel jaw gripper can grasp the plug’s sides, and the camera can see the plug’s top surface. A visual tag (a checkerboard) is mounted on the top surface of the plug to simplify plug localization. By tracking this tag, the robot estimates the pose of the the plug relative to the robot. Note that with this procedure, the PR2 does not receive direct feedback about the pose of the plug relative to the socket. If the robot were moved after the outlet localization phase, then error would be introduced, even if the robot later acquired an accurate estimate of the plug pose in the (new) robot frame. The plugging in procedure presented in [2] is generally not accurate enough to place the plug directly in the socket; the PR2 performs multiple insertion attempts (each at a slightly different position), detecting failure or success by the depth (Z distance) at which contact first occurs. (This is the sense in which touch is used for the final phase of the PR2’s plugging in procedure.) In part because of the requirement for multiple insertion attempts, the PR2’s plugging in procedure is very slow, requiring as many as several minutes to achieve one successful insertion. The procedure is apparently fairly robust: [2] reported 10 successes in 10 trials. (However, this figure includes some failed attempts after which the entire procedure was re-started and re-tried automatically; successful retries were counted as successes.)

C. *Powerline positioning*

Patel et al. [6] have demonstrated sub-room (approximately 3 m) accuracy using powerline positioning. In this scheme, RF signals are injected into a house’s wiring infrastructure from two fixed base stations plugged into two of the house’s sockets. However, according to our rules, we must avoid infrastructure modifications such as transmitting localization beacon signals through the building wiring. In addition, for the plugging in task, we need millimeter scale accuracy; meter scale accuracy is not sufficient. Meter-scale localization techniques may, however, be useful for coarse localization of outlets, relaxing the requirements for a SLAM navigation system and maps annotated with outlet locations. Haverinen et al. describe a technique in [7] for localization based on ambient fields that does not require infrastructure modification that may also be useful for coarse outlet localization.

D. Electric Field Pretouch

Previous work such as [8], [9] introduced the use of Electric Field Pretouch for robotics. In this prior work on E-Field Pretouch, a transmit electrode generates a signal (with frequency on the order of 100 kHz) that is synchronously detected on a sense electrode. In the *Powerline* Electric Field Pretouch technique reported here, the sensor unit has a receive electrode only. The “transmit” signal is the 60 Hz line frequency emitted from the socket. In the present system, the receiver is not synchronous with the transmitter, which reduces sensitivity compared with the synchronous case.

IV. SOLUTION CONCEPT

To insert a plug into a socket, the plug prongs must be accurately positioned over the socket openings. We hypothesized that the location of the socket openings could be inferred from the location of the peaks of the 60 Hz electric field strength in the vicinity of the outlet. To test the hypothesis, we developed a sensor, integrated into a working electrical plug, that senses the 60 Hz emissions from the socket. Since our sensor cannot directly detect signal strength peaks, we estimate the location of the peaks from a series of measurements made with the plug at different positions, and then move the plug to the inferred socket location.

1) *Mechanical plug fixture*: To enable the robot to reliably and consistently grasp the plug in a known orientation, we designed and built a specialized fixture (Fig. 2). The plug fixture consists of a 3D printed plastic housing with guides for the three fingers of the Barrett Hand, and a place for part of an off-the-shelf electrical plug to be attached. The enclosure also holds the sensor board in place.

The fixture is designed so that the guides will align the same way with the fingers of the hand every time that it grasps it, and so that it cannot move inside the hand once grasped.

2) *Sensor electrodes*: The sensor board is capable of selecting one of two separate electrodes. (The sensor board contains an independent amplifier for each electrode, the outputs of which are selected by an analog multiplexer in the microcontroller’s ADC.) Our solution uses a large electrode for coarse outlet localization and a small electrode for precise location of the terminals. The large electrode provides mid-range measurements (on the order of several tens of centimeters) at the cost of greater noise and less precision. The other electrode has a small cross-sectional area, so it provides greater precision, but must be brought very close to the outlet to detect it.

In our prototype hardware, we used a disc of copper foil placed on the front surface of the plug as the large electrode. This was uninsulated on the prototype device, but could be encased within the plastic plug without impairing its ability to sense the electric field. This would protect it from potentially shorting out the prongs of the plug if the adhesive on the copper foil failed.

For the short-range electrode, we used the ground prong on the plug itself. The ground prong is convenient because it can be brought very close to the outlet during the scans, but

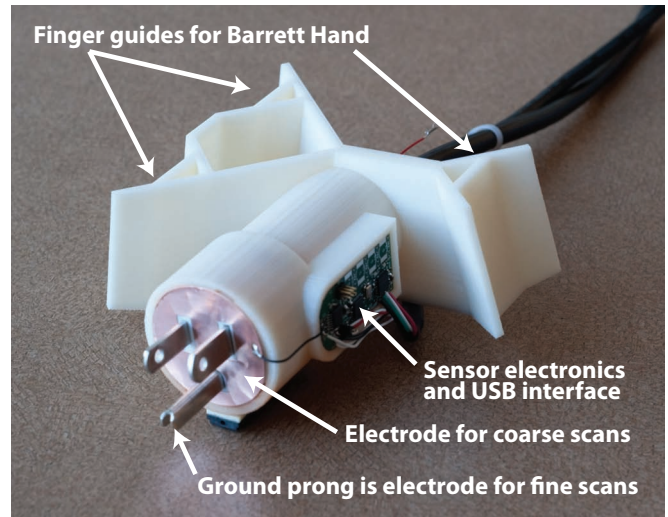

Fig. 2. MARVIN’s custom electrical plug designed for autonomous plugging in. The 3D printed housing, which encloses the electrical plug and sensor electronics, has finger guides that are designed to allow the Barrett Hand to grasp the plug reliably. The copper disk at the back of the plug a sense electrode for long range, coarse position measurements. The ground prong, in addition to its electrical function, serves as a sensor electrode for fine position measurements.

does not need to be retracted out of the way when the robot actually plugs in. For our experiments, the ground prong in the plug was not actually connected to the frame of the robot, which simplified the power supply to the sensor board. If the ground prong were actually connected to the frame of the robot for safety, an isolated power supply and communication interface would be required for the sensor board.

Ideally, the electrodes would be placed so that maximizing the signal strength would put the prongs in their final locations for plugging in, removing the need for the robot to move the plug by a fixed offset after the peaks in the signal are located. One approach would be to use the hot prong on the plug itself, but it is difficult to couple the sensor to the hot prong in a way that it is sensitive enough to locate the outlet but is able to tolerate mains voltage when plugged in. Another approach would be to use separate electrodes that are either placed so that they do not interfere with plugging in, or can retract out of the way when the plug enters the socket.

V. SOLUTION DETAILS

A. Detailed Requirements

U.S. electrical plugs and outlets conform to the requirements of the National Electrical Code (“NEC”); their dimensions are specified by standard WD6-2002 [10] from the National Electrical Manufacturer’s Association (“NEMA”). All modern U.S. outlets in home and office spaces (called NEMA 5-15 outlets) have three receptacles: one for a grounding prong, one called “hot” that carries the AC signal, and another referred to as “neutral,” which is the return path for the current in ordinary operation. (The grounding prong is a redundant element that can perform this function in abnormal situations to reduce the risk of electric shock.)

The grounding prong is longer than the other two prongs, and thus must be inserted before the other two prongs. Once

the ground prong has been successfully inserted, the hot and neutral plugs cannot be translated to incorrect X and Y values. Thus the essential problem is to insert the ground prong into its receptacle.¹

The receptacle for the ground prong is required to be a “D” shape at least 0.205 inches (5.2 mm) on each side. The tips of grounding plugs are shaped to facilitate alignment during insertion (the tip may be hemispherical, or a curved U shape). If the ground prong is misaligned by more than half the receptacle dimension (i.e. by more than 2.6 mm) in either direction, insertion will generally not succeed. Thus it appears that the required precision in either direction is around 2 mm.

B. Sensing modalities

1) Navigation and laser-based wall pose refinement:

To begin plugging in, the robot first needs to navigate to an electrical outlet. We provided the robot with a SLAM-generated 2D map of its environment annotated with the locations and approximate heights of electrical outlets, which are specified by ADA guidelines to be no less than 15 inches above the floor. [11]

The robot uses the ROS navigation stack [12], [13] to generate a plan and drive the base to an outlet. After the navigation system finishes moving the base, it is positioned near the outlet with translational errors on the order of ± 15 cm and orientation errors on the order of ± 5 degrees.

The distance between the robot and the wall is critical, since the arm is extending out to near the edge of its workspace to be able to reach the outlet. If the robot is too far away from the wall, then it will not be able to complete its scans or plug in because it can’t reach the required plug positions and orientations. On the other hand, if the robot is too close to the wall, then the elbow will collide with the wall during the procedure. The ± 15 cm translational accuracy in the navigation system is not sufficient to reliably place the robot base at a distance from the wall that enables the procedure to complete successfully.

To overcome the wall distance problem, the robot uses the laser range readings over a 30 degree arc in front of the robot to determine both the distance to the wall and the precise orientation of the robot with respect to the wall. A simple controller uses this information to make adjustments to the position and orientation of the robot after the navigation planner completes. The precise angle of the wall is also used throughout the rest of the procedure to keep the plug perpendicular to the wall surface, even if the robot base itself is not.

¹It is also necessary that the plug not be rolled along its axis, or the hot and neutral plugs could misalign with their receptacles even with the ground prong in place. Also, it is necessary for the plug to approach the socket orthogonally (limited pitch or yaw), or again it is possible for the hot and neutral to mis-align even with the tip of the ground prong in its receptacle. Setting these initial conditions correctly requires a reasonably well-functioning localization system, but this is not the limiting factor in the problem.

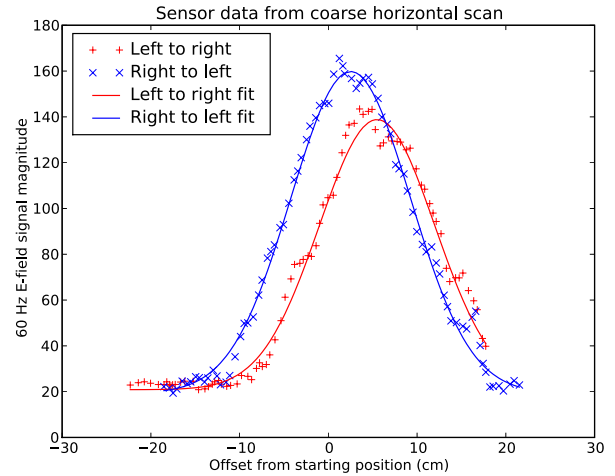

Fig. 3. Results of coarse horizontal scans. Individual data points are experimental data; solid lines are Gaussian fits. A left to right scan and a right to left scan are shown. The estimate used is the midpoint of the two maxima. The hysteresis between the left to right and right to left scans is due to actuation and network/software delays, not the sensors or signal processing.

2) *Outlet sensing and peak estimation:* To accurately locate the outlet with sub-millimeter precision, a scanning technique is used. This allows the robot to locate the position along an axis where the E-field signal strength is maximized, using only a single sensor channel at a time. A further advantage of this scanning procedure is noise reduction. Position and E-field measurement noise generally lead to estimation error. By fitting the data from a scan with an appropriate parametric model, we can effectively filter out the noise, given enough data. Measurements made far from the signal strength maximum nevertheless contribute to improving the accuracy of the estimate of the peak location.

The scanning procedure and peak estimation procedure described in this section is used several times during the plugging in routine with different parameters to eventually locate the outlet.

First, the robot moves the plug from its current position to one end of the region to be scanned. It then moves along a vector in the direction of the scan. Once it reaches the end of the scan region, it reverses direction and scans back to the starting position. The scan is conducted in both directions so that the effect of hysteresis due to actuation or system latency can be eliminated from the final result.

During both scan directions, the actual joint positions of the arm and the E-field signal strength at each step are recorded. After the scan completes, a Gaussian function is fit to the E-field data points for each scan direction. We fit a Gaussian function because the data from the scans appear to be qualitatively Gaussian and one of the parameters of the fit (the mean) directly indicates the location where the E-field signal strength was maximal. The robot computes the inverse kinematics solution that will place the plug at this location along the scan and then moves the arm before proceeding.

C. Alignment algorithm

1) *Coarse Scan:* After the navigation procedure completes and the distance between the base and the wall and

the orientation of the base have been corrected, there may be as much as ± 15 cm of translational error between the base and the outlet. To roughly locate the outlet, the robot moves the plug to a position in front of the base, about 10-15 cm away from the wall. It then performs a fast horizontal scan about 35 cm wide to locate and move the arm to the approximate center of the outlet. This scan is performed with the large electrode on the flat surface of the plug to obtain long-range E-field measurements. Fig. 3 shows E-field data and the curves fit during one of these scans. After the coarse scan is complete, the plug will be horizontally aligned with the outlet within a few centimeters.

2) *Touch-based wall distance refinement*: Once the robot knows the location of the outlet within a few centimeters, it moves closer to the wall to perform a series of high-resolution scans to precisely locate the receptacles for the prongs. These scans must be performed very close to the wall and outlet for optimal precision. The robot locates the wall in the coordinate frame of the arm by slowly moving the arm forward until the error between the commanded and actual positions of the compliant arm exceeds a set threshold. This happens when the plug touches the wall and can no longer move forward. Once the wall has been located, the plug is moved back by a few centimeters to give it room to perform the scans.

3) *Fine horizontal scan*: Another horizontal scan is performed, but at a slower speed (2 cm/s) and over a narrower range (10 cm.) For this scan, the ground prong of the plug is used as the electrode for greater sensing precision.

During this scan, the sensor detects a narrow region of high signal strength that corresponds to the position of the electrical contacts just inside the opening for the hot terminal on the outlet. This point is reliably detected because it is where the 60 Hz signal is closest to the sensor electrode.

After this scan completes, the ground prong of the plug is positioned horizontally so that the ground prong is on the vertical axis that passes through the two hot terminals on the outlet. Example data and fits from one of these scans are shown in Fig. 4.

4) *Fine vertical scan*: Next, a final scan is performed along the vertical axis, once again using the ground prong as the sensor electrode, a 2 cm/s scanning speed, and a scan range of 12 cm. During this scan, the sensor detects a broader region of high signal strength corresponding to the region between the two hot terminals on the outlet, which are connected internally by a bus bar (the signal strength is highest at the vertical center of this bar.)

At the end of the vertical scan, the ground prong will be centered vertically between the two hot terminals. Example data from one of these scans are shown in Fig. 5.

We decided that it was not necessary to perform a coarse vertical scan before the fine one, since there is relatively little uncertainty about the height of the outlet. In an environment with outlets of varying heights, a coarse vertical scan could be used to perform rough vertical localization of the outlet as well.

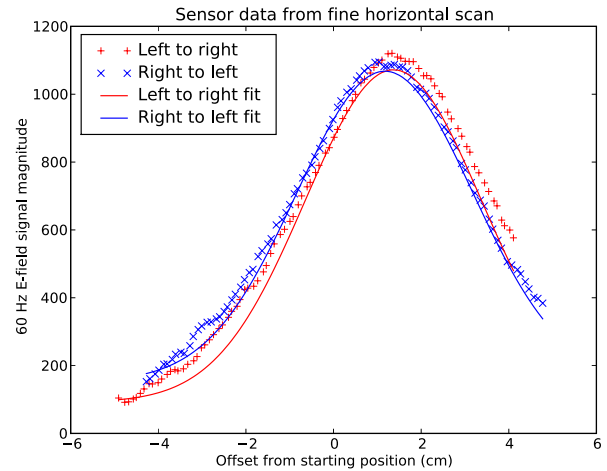

Fig. 4. Results of fine horizontal scans. Individual data points are experimental data; solid lines are Gaussian fits. A left to right scan and a right to left scan are shown. The estimate used is the midpoint of the two maxima.

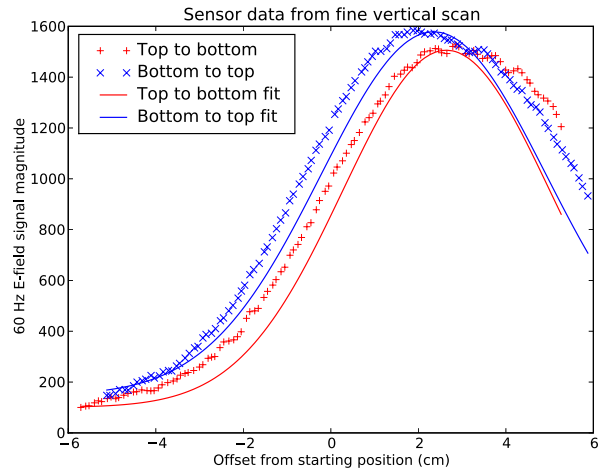

Fig. 5. Results of fine vertical scans. Individual data points are experimental data; solid lines are Gaussian fits. A bottom to top scan and a top to bottom scan are shown. The estimate used is the midpoint of the two maxima.

5) *Plugging in*: The complete scanning procedure accurately localizes the sensor electrode (the ground prong) to the intersection of the horizontal and vertical axes where the E-field signal strength is maximized. This location is the point vertically centered between the two hot terminals on the duplex outlet. Before plugging in, the robot needs to move the plug up and to the left to align the prongs with the openings on the outlet. Since the dimensions of the outlet are standardized, this can be done by applying fixed translational offsets to the position of the plug.

Finally, with the plug aligned precisely with the openings in the outlet, the plug moves straight forward and the prongs enter the proper receptacles.

D. Mobile Manipulation Platform: MARVIN

We implemented the plugging in technique on MARVIN, the mobile manipulation platform constructed at Intel Labs Seattle. MARVIN has a Segway RMP-50 mobile base, Barrett WAM arm, and Barrett Hand (BH8). It has two onboard computers, one for arm control, and one for navigation and

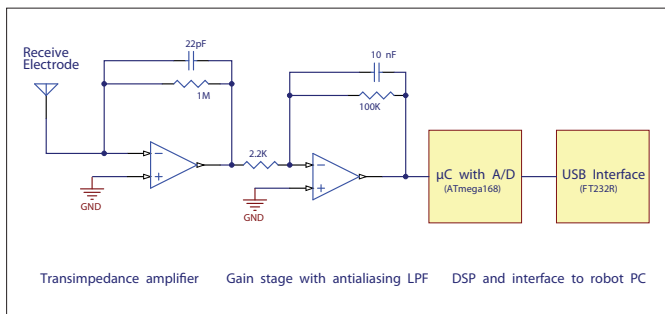

Fig. 6. Schematic of circuit used to sense 60Hz electric fields emitted from standard electrical socket.

application execution. It has a custom power subsystem, including on-board batteries that can be recharged by plugging in, voltage and current metering, and the ability to power down or up various subsystems.

E. Sensor electronics

The sensor board mounted on the plug consists of three parts: an analog front-end, a microcontroller for A/D conversion and signal processing, and a USB interface for connection to the robot’s application PC. A schematic overview of the sensor electronics is shown in Fig. 6.

The analog front-end is a two-stage op-amp circuit. The first stage is a high-gain transimpedance amplifier which amplifies the small currents induced in the receive electrode by the electric field being sensed and converts these currents to proportional voltages. The second stage applies a voltage gain to further amplify the signal voltages to the full range of the A/D converter on the microcontroller. This stage also acts as an active low pass filter to prevent aliasing when the signal is sampled at 500 Hz.

The output of the analog front-end is fed into the A/D converter of an 8-bit microcontroller, which samples the signal at 500 Hz and performs filtering (described further in the following section) to recover the magnitude of the 60 Hz signal.

Finally, filtered sensor readings are communicated back to the robot’s PC over USB at a rate of approximately 50 Hz.

F. Signal processing

1) *Anti-aliasing filter*: An active low-pass filter with a cutoff frequency $\omega_c = 160$ Hz is integrated into the voltage gain stage in the analog front-end circuit on the sensor board. This prevents aliasing when the signal is sampled at 500 Hz by the microcontroller’s A/D.

2) *Digital bandpass filter and magnitude measurement*: The microcontroller firmware implements a 31st-order digital FIR bandpass filter with a center frequency of 60 Hz and a bandwidth of about 3 Hz. The coefficients for this filter were calculated with the Filter Design Toolbox in MATLAB. The frequency response plot of this filter is shown in Fig. 7.

The filter window is shifted recomputed for each new A/D sample. The output of the filter is then rectified and averaged over several periods of the filtered waveform to estimate its DC magnitude, which is sent back to the PC at 50 Hz. An

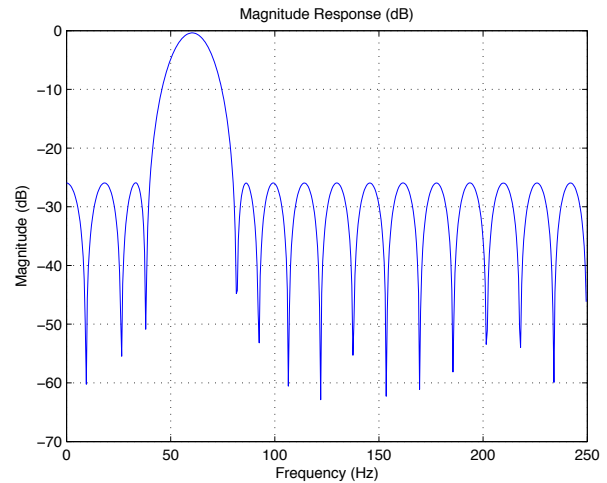

Fig. 7. Frequency response of the bandpass filter used to detect the signal emitted from the outlet by the 60Hz line frequency. The response is centered on 60Hz, and has a bandwidth (width at 3dB of attenuation) of about 3Hz. The coefficients for the 32 tap FIR filter were computed in MATLAB. The filter is executed on the Atmel microcontroller on the sensor board at 500 Hz (the sensor sample rate).

IIR low-pass filter is used to average the 10 measurements that are completed between sending updates to the PC.

3) *Additional low-pass filtering*: An additional IIR low-pass filter is implemented in software on the PC to smooth out low frequency noise in the sensor magnitude signal.

VI. RESULTS

A. End-to-end task success

We tested the plugging in process in 30 trials in a single outlet. In each the robot was placed in a random initial condition, from 2 m and 10 m from the outlet. After navigating to the outlet, the robot scanned with its field sensors as described previously, and attempted to plug in. It succeeded in 28 of the 30 trials, for a success rate of 93%. The mean time to plug in (after the robot had stopped navigating) was 64.4 ± 1.3 s. We also performed 3 additional trials in another outlet, with no further system tuning apart from annotating the second outlet on the map. All 3 trials with the second outlet were successful.

B. Localization precision

To characterize the system’s end-to-end performance, we measured localization precision in a series of 36 trials. The results are plotted in Fig. 8. The standard deviation of the spread of localization results was 0.5 mm in both the horizontal and vertical directions. The localization point cloud is overlaid with an outline of the target ground prong receptacle. Both these results and the task success show that our system has sufficient precision to perform the task successfully most of the time.

C. Procedure for characterizing precision

The measurements were made by attaching a small laser pointer to the plug apparatus and measuring the location of the laser spot in the plane of the socket. Fig. 9 shows the laser affixed to the plug, illuminating a grid used for

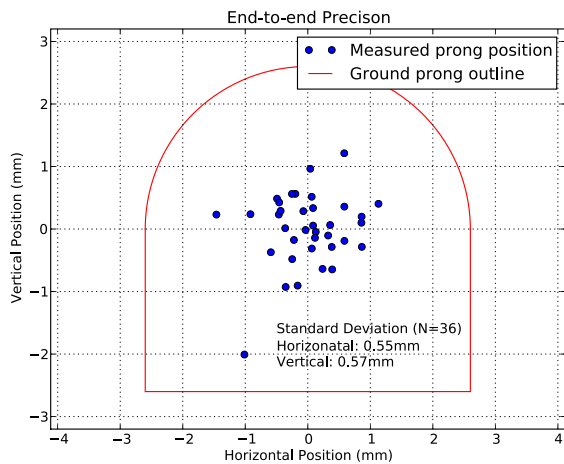

Fig. 8. Spread in positioning after E-Field alignment. This shows the end to end alignment performance of the system. The largest error observed in the 36 trials was $\sqrt{5}$ mm = 2.2 mm. The alignment point cloud is overlaid on an outline of the ground prong receptacle. All the points fall within the target ground prong outline.

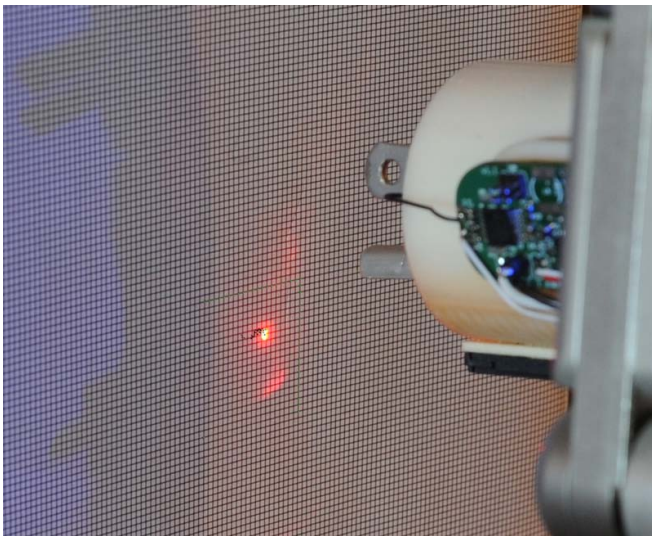

Fig. 9. Apparatus used to estimate positioning precision.

ground truth position measurement. A digital photograph of the spot illuminating the grid was taken after each trial. The pixel coordinates of the centroid of the laser spot were extracted manually from each photograph using image editing software, and corrected to X,Y measurements using an affine transformation derived from the grid.

D. Cost

The sensor hardware added to the plug consists of a printed circuit board and readily available, low-cost ICs and components, and the electrodes can be constructed of any conductive material. The cost of the hardware in quantity would be a fraction of the cost of a camera sufficient for computer vision. The computational and power costs are also much less than for a vision-based approach, making this solution ideal for low-cost and low-power robotic platforms.

VII. DISCUSSION

The system’s end to end localization performance is limited by two types of errors, estimation error, and actuation error.

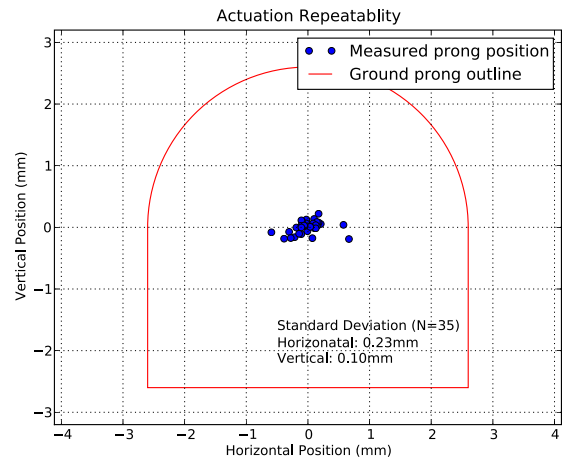

Fig. 10. Uncertainty due to “pure” actuation error. This figure was made by bringing the robot arm to a variety of randomly chosen joint angles, and commanding it to return to the same set of joint angles, 35 times. An additional (larger) source of actuation error (not captured by this figure) is due to small variations of the final IK solution with the initial condition, for iterative Jacobian inverse kinematics. Thus this figure illustrates the minimum possible actuation uncertainty provided by the arm. In practice, the uncertainty is larger.

ror. Fig. 9 shows the distribution of the combined estimation-plus-actuation error. Even with a perfect estimate of the socket location, the movement from the final scan location to the socket is imperfect, and introduces error. Actuation error can be caused by encoder errors, drive train backlash, and cable stretch. To understand the factors limiting system performance better, we characterized the actuation error in isolation (without localization error) by commanding the plug to move from a random starting location to a fixed final location. Measurements over 35 trials were taken using the laser and photographic system described above. The result is shown in Fig. 10.

Comparing Figs. 9 and 10, it is interesting to note that 20% to 40% of the combined error can be explained by actuation error. Reducing the actuation error would be difficult and expensive—the WAM is a high-quality arm. However, if we could sense the peak locations directly (e.g. with a split electrode sensor) we could implement a controller to servo the plug to the peaks. This closed loop control would effectively eliminate the actuation error, opening the possibility that a much less precise (and much less expensive) manipulator could accurately position the plug over the socket.

A. Limitations and extensions

Our system is currently limited to working with standard U.S. electrical plugs, which have separate ground terminals. The technique could be extended to other plug types without a ground prong by using the neutral terminal or a separate electrode instead. The system would also need to be re-tuned to detect a 50 Hz signal in some countries.

We have tested the alignment process in a commercial building, not an ordinary home. In the U.S., it is usual for commercial buildings to use electrical cable in shielded conduit, but this is not generally the case in homes. While we expect our procedure to work in residential buildings, it is possible that additional AC signal from unshielded

conduit would degrade the system performance by providing confounding signals. However, we believe this effect will be small because the unshielded cables in the wall would typically be recessed several centimeters behind the wall circuit and the sensor will measure a much larger peak from the contacts in the socket itself than from the wiring because the contacts are physically closer. Unshielded cable may actually be useful to the robot—it could follow the signal from the wires inside the walls to locate outlets.

The present system assumes that the outlets that the robot tries to plug in to are unobstructed. In the event that something is already plugged in to the outlet, the robot could detect this by monitoring for collisions during the scanning procedure. If a large object (such as another robot) is already plugged into the outlet, this could also be detected by the robot's navigation and obstacle avoidance systems.

VIII. FUTURE WORK

Our work thus far has assumed that the robot is provided with the locations, heights, and orientations of outlets on its map, and has focused on overcoming actuation errors due to navigation and manipulation processes. A natural extension of this work would be enabling the robot to find the outlets itself. Vision and/or a longer range E-field sensor (perhaps a large electrode along the side of the robot base, such as the one used in [4]) could be used to locate previously unknown outlets at long range as the robot drives around its environment. Since outlets can be installed in four distinct orientations (the ground prong can be oriented to the left, right, bottom, or top of the socket) the robot would also need to determine the orientation of outlets it discovers. In some cases, the robot might be able to use the grouping of multiple sockets, such as the standard duplex outlet, to determine the outlet orientation. Or, the robot could try plugging in with different orientations until one succeeds. The approximate height of outlets could be determined by conducting a coarse vertical scan in the vicinity of the outlet. Both the outlet height and orientation are very unlikely to change once they have been learned, so the robot could annotate its map with this information for future use.

The 60 Hz E-field sensor could likely also be extended to detect switches. This could enable the robot to find and operate switches in its environment. Additionally, if the robot can precisely locate outlets and switches, these could be used as ubiquitous signal beacons—reference points for precise localization beyond the resolution that a laser rangefinder-based system can provide.

The system described here does not operate as a closed loop control system. This is because our sensor does not directly measure peaks of the e-field distributions. Our system only measures the value of the e-field, not the slope, so to find the peak location, we resort to using a scanning procedure. Scanning is slow, but perhaps more importantly, accurate actuation is required to move from the end-of-the-scan location to the peak location derived from the scan, since this movement is done open-loop. However, if one could devise a sensor design in which the zero of the sensor

coincided with the system goal then true closed loop control could be used. For example, imagine replacing the single sense electrode of our current system with three electrodes distributed 120 degrees apart around a central point. The difference in the signals from these electrodes would measure the gradient of the electric field strength, and can be used as the error signal of a position controller, guiding the sensor directly to the peak. A system like this might reduce time required to find the socket or require less actuation accuracy lending itself to less expensive robots.

IX. CONCLUSION

This paper presented a practical scheme that allows a robot to plug itself in to a standard, unmodified electrical outlet for recharging. The system works by sensing the 60 Hz emissions naturally caused by the AC electricity in the outlet. The technique could provide a reliable mechanism for low-cost robots to plug themselves in for recharging that does not require any robot-specific infrastructure.

Videos illustrating the systems described in this paper are available at <http://www2.seattle.intel-research.net/~jrsmith/icra10EFPlugIn/>.

X. ACKNOWLEDGMENTS

We thank Dieter Fox for helpful conversations about this work.

REFERENCES

- [1] W. Walter, "An imitation of life," *Scientific American*, vol. 182, pp. 42–45, 1950.
- [2] D. S. D.P. Watson, "Autonomous systems," *Johns Hopkins APL Technical Digest*, vol. 26, no. 4, 2005.
- [3] E. Torres-Jara, "A self-feeding robot," Master's thesis, Massachusetts Institute of Technology, 2002. [Online]. Available: <http://people.csail.mit.edu/etorresj/MST/main.pdf>
- [4] A. Bagepalli, M. Zamora, and D. Sanchez. (2005) Charger the wall charging robot. [Online]. Available: <http://www.engr.panam.edu/ee/labs/senior/website/index.htm>
- [5] S. Chitta, E. Berger, G. Bradski, T. Foote, B. Gerkey, S. Glaser, J. Hsu, K. Konolige, E. Marder-Eppstein, B. Marthi, C. McGann, W. Meeussen, P. Mihelich, M. Muja, V. Pradeep, R. Rusu, M. Wise, and K. Wyrokek, "Autonomous door opening and plugging in with a personal robot," in *RSS*, ser. Mobile Manipulation Workshop, 2009. [Online]. Available: <http://www.scribd.com/doc/17046768/rssmain09>
- [6] S. N. Patel, K. N. Truong, and G. D. Abowd, "Powerline positioning: A practical sub-room-level indoor location system for domestic use," in *UbiComp*, ser. Lecture Notes in Computer Science, P. Dourish and A. Friday, Eds., vol. 4206. Springer, 2006, pp. 441–458.
- [7] J. Haverinen and A. Kemppainen, "Global indoor self-localization based on the ambient magnetic field," *Robotics and Autonomous Systems*, vol. 57, no. 10, pp. 1028–1035, 2009.
- [8] R. Wistort and J. R. Smith, "Electric field servoing for robotic manipulation," in *IROS*. IEEE, 2008, pp. 494–499.
- [9] J. R. Smith, É. Garcia, R. Wistort, and G. Krishnamoorthy, "Electric field imaging pretouch for robotic graspers," in *IROS*. IEEE, 2007, pp. 676–683.
- [10] *Wiring Devices—Dimensional Specifications ANSI/NEMA WD6-2002*, National Electrical Manufacturer's Association (NEMA), Rosslyn, VA, 2008. [Online]. Available: <http://www.nema.org>
- [11] *Accessibility Guidelines for Buildings and Facilities (ADAAG)*, Americans with Disabilities Act, 2002. [Online]. Available: <http://www.access-board.gov/adaag/html/adaag.htm>
- [12] M. Quigley, K. Conley, B. Gerkey, J. Faust, T. B. Foote, J. Leibs, R. Wheeler, and A. Y. Ng, "Ros: an open-source robot operating system," in *ICRA*, ser. Open-Source Software workshop. IEEE, 2009.
- [13] (2009) Ros navigation stack wiki article. [Online]. Available: <http://www.ros.org/wiki/navigation>